

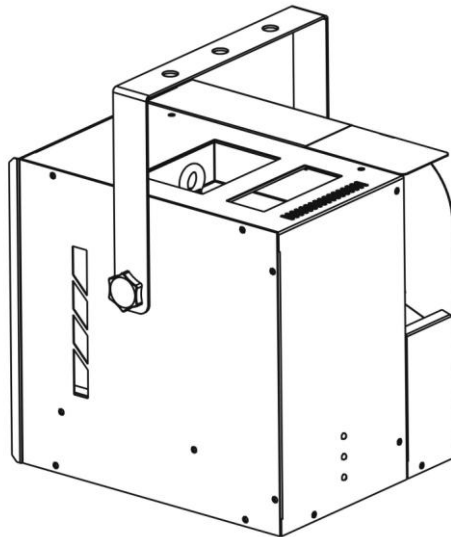

Snapshot

Use on Dimmer	⊘
Outdoor Use	⊘
Sound Activated	⊘
DMX512	✓
Master / Slave	⊘
115 V / 230 V Switch	⊘
Replaceable Fuse	✓
User Serviceable	⊘
Duty Cycle	⊘

User Manual

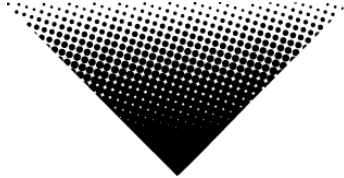

3000 N 29th Ct, Hollywood, FL 33020 U.S.A.
(800) 762-1084 – (954) 929-1115
FAX (954) 929-5560
www.chauvetlighting.com

TABLE OF CONTENTS

1. BEFORE YOU BEGIN	3
WHAT IS INCLUDED	3
UNPACKING INSTRUCTIONS	3
AC POWER	3
SAFETY INSTRUCTIONS.....	4
2. INTRODUCTION	4
FEATURES.....	4
DMX CHANNEL SUMMARY.....	4
PRODUCT OVERVIEW.....	5
3. SETUP	6
FUSE REPLACEMENT	6
FIXTURE LINKING.....	6
DATA CABLING.....	6
<i>DMX Data Cable</i>	6
<i>Cable Connectors</i>	7
<i>3-Pin to 5-Pin Conversion Chart</i>	7
SETTING UP A DMX SERIAL DATA LINK.....	7
MOUNTING	8
<i>Orientation</i>	8
<i>Rigging</i>	8
4. OPERATING INSTRUCTIONS	8
DMX MODE	8
DMX CHANNEL VALUES.....	8
WIRED REMOTE (HH1) (INCLUDED)	9
CONTACT US.....	10
5. APPENDIX	10
DMX PRIMER.....	10
SETTING THE DMX STARTING ADDRESS.....	11
<i>DMX Quick Reference Chart</i>	12
GENERAL TROUBLESHOOTING	13
TECHNICAL SUPPORT.....	13
RETURNS PROCEDURE.....	15
CLAIMS.....	15
TECHNICAL SPECIFICATIONS	16

1. BEFORE YOU BEGIN

What is included

- 1 x Hurricane™ Haze
- 1 x Wired Remote (HH1)
- 1 x Power Cord
- 1 x Warranty Card
- 1 x User Manual

Unpacking Instructions

Immediately upon receiving a fixture, carefully unpack the carton, check the contents to ensure that all parts are present, and have been received in good condition. Notify the shipper immediately and retain packing material for inspection if any parts appear damaged from shipping or the carton itself shows signs of mishandling. Save the carton and all packing materials. In the event that a fixture must be returned to the factory, it is important that the fixture be returned in the original factory box and packing.

AC Power

To determine the power requirements for a particular fixture, see the label affixed to the back plate of the fixture or refer to the fixture's specifications chart. A fixture's listed current rating is its average current draw under normal conditions. All fixtures must be powered directly off a switched circuit and cannot be run off a rheostat (variable resistor) or dimmer circuit, even if the rheostat or dimmer channel is used solely for a 0% to 100% switch. Before applying power to a fixture, check that the source voltage matches the fixture's requirement. Check the fixture or device carefully to make sure that if a voltage selection switch exists that it is set to the correct line voltage you will use.

Warning! ***Verify that the voltage rating on your unit matches the line voltage applied. Damage to your fixture may result if the line voltage applied does not match the voltage indicated on the rating. All fixtures must be connected to circuits with a suitable Earth Ground.***

Safety Instructions



Please read these instructions carefully, which includes important information about the installation, usage and maintenance of this product.

- Please keep this User Guide for future consultation. If you sell the unit to another user, be sure that they also receive this instruction booklet.
- Always make sure that you are connecting to the proper voltage, and that the line voltage you are connecting to is not higher than that stated on the decal or rear panel of the fixture.
- This product is intended for indoor use only! To prevent risk of fire or shock, do not expose fixture to rain or moisture.
- Make sure there are no flammable materials close to the unit while operating.
- The unit must be installed in a location with adequate ventilation, at least 20 in (50 cm) from adjacent surfaces. Be sure that no ventilation slots are blocked.
- Always disconnect from power source before servicing or replacing lamp or fuse and be sure to replace with same lamp source.
- Secure fixture to fastening device using a safety chain.
- Maximum ambient temperature (Ta) is 104° F (40° C). Do not operate fixture at temperatures higher than this.
- In the event of a serious operating problem, stop using the unit immediately. Never try to repair the unit by yourself. Repairs carried out by unskilled people can lead to damage or malfunction. Please contact the nearest authorized technical assistance center. Always use the same type spare parts.
- Never connect the device to a dimmer pack.
- Make sure the power cord is never crimped or damaged.
- Never disconnect the power cord by pulling or tugging on the cord.

Caution! *There are no user serviceable parts inside the unit. Do not open the housing or attempt any repairs yourself. In the unlikely event your unit may require service, please contact CHAUVET at: 954-929-1115.*

2. INTRODUCTION

Features

- 2-channel DMX-512 hazer
- Adjustable haze output via DMX, wired remote or control panel on rear
- Adjustable fan speed via DMX, wired remote or control panel on rear

Additional Features

- True continuous output
- Variable output angle
- Low fluid indicator
- Wired multi-function remote included
- Water-based hazer

DMX Channel Summary

CHANNEL	FUNCTION
1	Haze output
2	Blower/fan speed

Product Overview

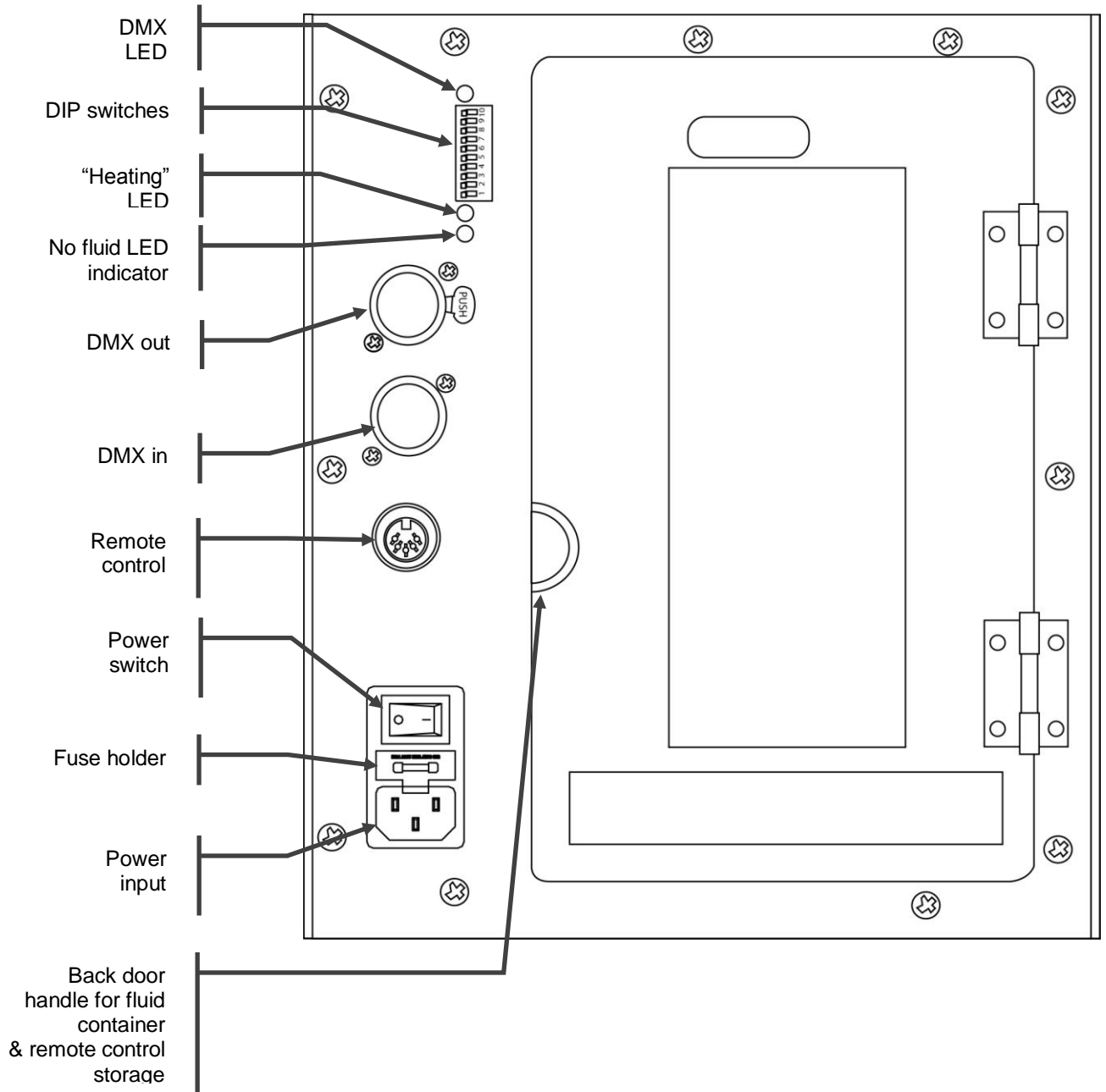

3. SETUP



Disconnect the power cord before replacing a fuse and always replace with the same type fuse.



Fuse Replacement

With a flat head screwdriver wedge the fuse holder out of its housing. Remove the damaged fuse from its holder and replace with exact same type fuse. Insert the fuse holder back in its place and reconnect power.

The fuse is located inside this compartment. Remove using a flat head screwdriver.

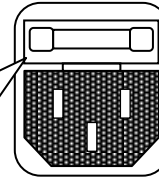

Fixture Linking

You will need a serial data link to run light shows of one or more fixtures using a DMX-512 controller or to run synchronized shows on two or more fixtures set to a master/slave operating mode. The combined number of channels required by all the fixtures on a serial data link determines the number of fixtures the data link can support.

Important: *Fixtures on a serial data link must be daisy chained in one single line. To comply with the EIA-485 standard no more than 32 fixtures should be connected on one data link. Connecting more than 32 fixtures on one serial data link without the use of a DMX optically-isolated splitter may result in deterioration of the digital DMX signal.*

Maximum recommended serial data link distance: 500 m (1640 ft)

Maximum recommended number of fixtures on a serial data link: 32

Data Cabling

To link fixtures together you must obtain data cables. You can purchase CHAUVET certified DMX cables directly from a dealer/distributor or construct your own cable. If you choose to create your own cable please use data-grade cables that can carry a high quality signal and are less prone to electromagnetic interference.

DMX Data Cable

Use a Belden© 9841 or equivalent cable which meets the specifications for EIA RS-485 applications. Standard microphone cables cannot transmit DMX data reliably over long distances. The cable will have the following characteristics:

Type:	shielded, 2-conductor twisted pair
Maximum capacitance between conductors:	30 pF/ft
Maximum capacitance between conductor and shield:	55 pF/ft
Maximum resistance:	20 ohms/1000 ft
Nominal impedance:	100 – 140 ohms

Cable Connectors

Cabling must have a male XLR connector on one end and a female XLR connector on the other end.

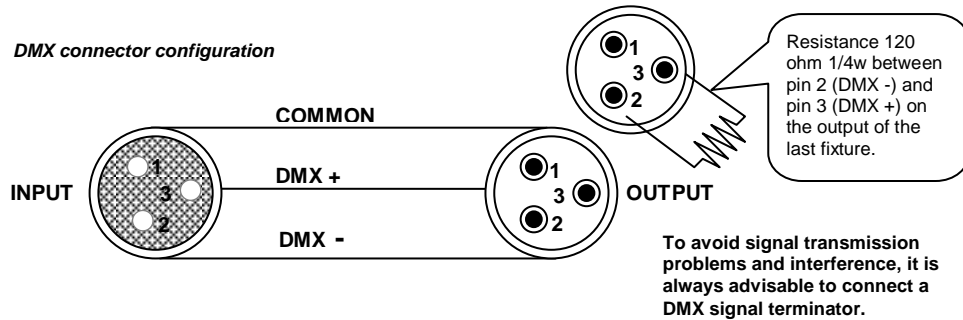

CAUTION Do not allow contact between the common and the fixture's chassis ground. Grounding the common can cause a ground loop, and your fixture may perform erratically. Test cables with an ohmmeter to verify correct polarity and to make sure the pins are not grounded or shorted to the shield or each other.

3-Pin to 5-Pin Conversion Chart

Note! If you use a controller with a 5-pin DMX output connector, you will need to use a 5-pin to 3-pin adapter. CHAUVET Model No: DMX5M, or DMX5F. The chart below details a proper cable conversion:

3 PIN TO 5 PIN CONVERSION CHART

Conductor	3 Pin Female (Output)	5 Pin Male (Input)
Ground/Shield	Pin 1	Pin 1
Data (-) signal	Pin 2	Pin 2
Data (+) signal	Pin 3	Pin 3
Not used		Pin 4
Not used		Pin 5

Setting up a DMX Serial Data Link

1. Connect the (male) 3-pin connector side of the DMX cable to the output (female) 3-pin connector of the controller.
2. Connect the end of the cable coming from the controller which will have a (female) 3-pin connector to the input connector of the next fixture consisting of a (male) 3-pin connector.
3. Then, proceed to connect from the output as stated above to the input of the following fixture and so on.

CHAUVET Certified DMX Data Cables

Order Code	Description
DMX1.5	DMX Cable 1.5 m/4.9 ft
DMX4.5	DMX Cable 4.5 m/14.8 ft
DMX10	DMX Cable 10 m/32.8 ft

Universal DMX Controller

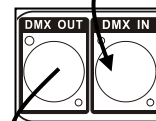
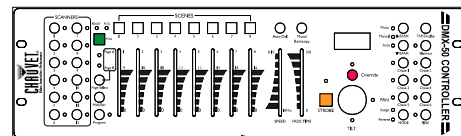

This drawing provides a general illustration of the DMX Input/Output panel of a lighting fixture.

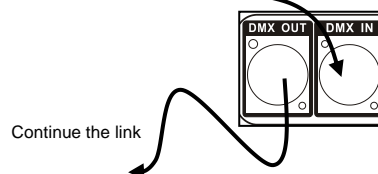

Mounting

Orientation

This fixture may be mounted in a hanging or sitting position, provided there is adequate room for ventilation.

Rigging

It is important never to obstruct the vents pathway. Mount the fixture using, a suitable "C" or "O" type clamp.

- When selecting installation location, take into consideration fluid replacement, access, and routine maintenance.
- Safety cables must always be used.
- Never mount in places where the fixture will be exposed to rain, high humidity, extreme temperature changes or restricted ventilation.

Hanging Clamp

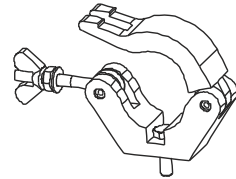

Note!
Clamp is sold separately.

4. OPERATING INSTRUCTIONS

DMX Mode

This mode allows the unit to be controlled by any universal DMX controller. If you are unfamiliar with DMX, please read the "DMX Primer section" in the Appendix of this manual.

- 1) This fixture will automatically switch to DMX mode, once a DMX controller has been plugged into the 3-pin DMX input.
- 2) Use DIP switches 1~9 to set the DMX address.

DMX Channel Values

CHANNEL	VALUE	FUNCTION
1	000 ⇔ 255	Haze output 0% ⇔ 100%
2	000 ⇔ 255	Blower/fan speed 0% ⇔ 100%

Wired Remote (HH1) (Included)

This is the controller that comes with the Hurricane™ Haze. There are 3 functions of this remote. Please see the below instructions for details on each of these operations.

Timer Function

- 1) Plug in the haze machine to power and turn the power switch to the fixture on.
- 2) Plug in the timer remote to the Manual Controller socket on the rear of the haze machine.
- 3) Press the <TIMER ON/OFF> button on the timer remote. The LED above the button should light, indicating activation of function.
- 4) You may now set the INTERVAL & DURATION adjustment knobs to the desired position.

Note: The < INTERVAL > is the time in between bursts of haze.

Note: The < DURATION > is the time that the haze machine will run during the burst.

Manual Function

1. Press the <MANUAL> button, and the haze machine will output haze for as long as you hold down the button, at full blower speed and 100% output.

Continuous Function

1. Press the <CONTINUOUS> button.
2. Adjust the <OUTPUT ADJUSTMENT KNOB> to desired position.

Note: The <INTERVAL> and <DURATION ADJUSTMENT KNOBS> will have no effect while the CONTINUOUS function is activated.

Note: The blower fan remains at full and the <OUTPUT ADJUSTMENT KNOB> controls the haze output.

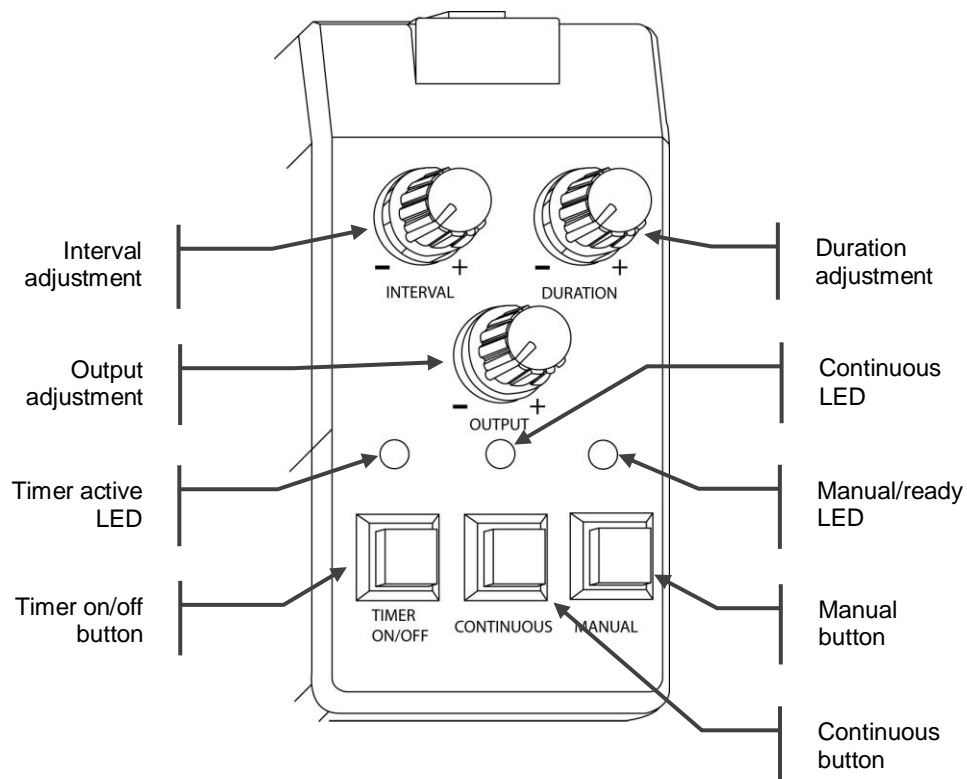

Contact Us

World Wide

General Information	CHAUVET 3000 North 29 th Court Hollywood, FL 33020 voice: 954.929.1115 fax: 954.929.5560 toll free: 800.762.1084
Technical Support	CHAUVET 3000 North 29 th Court Hollywood, FL 33020 voice: 954.929.1115 (Press 4) fax: 954.929.5560 (Attention: Service)
World Wide Web	www.chauvetlighting.com

5. APPENDIX

DMX Primer

There are 512 channels in a DMX-512 connection. Channels may be assigned in any manner. A fixture capable of receiving DMX 512 will require one or a number of sequential channels. The user must assign a starting address on the fixture that indicates the first channel reserved in the controller. There are many different types of DMX controllable fixtures and they all may vary in the total number of channels required. Choosing a start address should be planned in advance. Channels should never overlap. If they do, this will result in erratic operation of the fixtures whose starting address is set incorrectly. You can however, control multiple fixtures of the same type using the same starting address as long as the intended result is that of unison movement or operation. In other words, the fixtures will be slaved together and all respond exactly the same.

DMX fixtures are designed to receive data through a serial Daisy Chain. A Daisy Chain connection is where the DATA OUT of one fixture connects to the DATA IN of the next fixture. The order in which the fixtures are connected is not important and has no effect on how a controller communicates to each fixture. Use an order that provides for the easiest and most direct cabling. Connect fixtures using shielded two conductor twisted pair cable with three pin XLR male to female connectors. The shield connection is pin 1, while pin 2 is Data Negative (S-) and pin 3 is Data positive (S+). CHAUVET carries 3-pin XLR DMX compliant cables, DMX-10 (33'), DMX-4.5 (15') and DMX-1.5 (5')

Setting the DMX Starting Address

This DMX mode enables the use of a universal DMX controller device. Each fixture requires a "start address" from 1 to 512. A fixture requiring one or more channels for control begins to read the data on the channel indicated by the start address. For example, a fixture that uses 6 DMX channels and was addressed to start on DMX channel 100, would read data from channels: 100, 101, 102, 103, 104, and 105. Choose start addresses so that the channels used do not overlap, and note the start address selected for future reference.

If this is your first time addressing a fixture using the DMX-512 control protocol, we suggest jumping to the Appendix Section and reading the heading "DMX Primer section". It contains very useful information that will help you understand its use.

Set the start address using the group of DIP switches located usually on bottom of the fixture. Each DIP switch has an associated value. Adding the value of each switch in the ON position will provide the start address. Figuring out which switches to toggle ON given a specific start address can be accomplished by determining which switch values will add up to the address value, and turning these switches on. Do so by doing the following:

- 1) Determine the largest value switch that is less than the start address. Turn this switch on.
- 2) Subtract the value of the DIP switch you just turned on from the starting address number.
- 3) Determine the largest value switch that is less than the remainder from the previous subtraction. Turn this switch on.
- 4) Subtract the value of the switch you just turned on from the remainder of the previous subtraction.
- 5) Repeat steps three and four until you have a remainder of zero.

EXAMPLE STARTING ADDRESS

<p>Address 10</p> <p>Switch # 4 = 8 Switch # 2 = 2 Total = 10</p>	<p>256 128 64 32 16 8 4 2 1</p> <p>9 8 7 6 5 4 3 2 1</p>																				
<p>Address 24</p> <p>Switch # 5 = 16 Switch # 4 = 8 Switch # 2 = 2 Total = 26</p>	<p>256 128 64 32 16 8 4 2 1</p> <p>9 8 7 6 5 4 3 2 1</p>																				
<p>Resolving address using simple math.</p> <p>Address 233</p>	<table border="1"> <thead> <tr> <th>DIP SWITCH</th> <th>(DMX VALUE)</th> </tr> </thead> <tbody> <tr><td>1</td><td>1</td></tr> <tr><td>2</td><td>2</td></tr> <tr><td>3</td><td>4</td></tr> <tr><td>4</td><td>8</td></tr> <tr><td>5</td><td>16</td></tr> <tr><td>6</td><td>32</td></tr> <tr><td>7</td><td>64</td></tr> <tr><td>8</td><td>128</td></tr> <tr><td>9</td><td>256</td></tr> </tbody> </table>	DIP SWITCH	(DMX VALUE)	1	1	2	2	3	4	4	8	5	16	6	32	7	64	8	128	9	256
DIP SWITCH	(DMX VALUE)																				
1	1																				
2	2																				
3	4																				
4	8																				
5	16																				
6	32																				
7	64																				
8	128																				
9	256																				

DMX Quick Reference Chart

DMX Address Quick Reference Chart

Dip Switch Position

DMX DIP SWITCH SET 0=OFF 1=ON X=OFF or ON						#9	0	0	0	0	0	0	0	0	1	1	1	1	1	1	1	1
#1	#2	#3	#4	#5		#8	0	0	0	1	1	1	1	0	0	0	0	1	1	1	1	
#7	0	0	1	1	0	0	1	1	0	0	1	1	0	0	1	0	0	1	0	0	1	1
#6	0	1	0	1	0	1	0	1	0	1	0	1	0	1	0	1	0	1	0	1	0	1
0	0	0	0	0			32	64	96	128	160	192	224	256	288	320	352	384	416	448	480	
1	0	0	0	0		1	33	65	97	129	161	193	225	257	289	321	353	385	417	449	481	
0	1	0	0	0		2	34	66	98	130	162	194	226	258	290	322	354	386	418	450	482	
1	1	0	0	0		3	35	67	99	131	163	195	227	259	291	323	355	387	419	451	483	
0	0	1	0	0		4	36	68	100	132	164	196	228	260	292	324	356	388	420	452	484	
1	0	1	0	0		5	37	69	101	133	165	197	229	261	293	325	357	389	421	453	485	
0	1	1	0	0		6	38	70	102	134	166	198	230	262	294	326	358	390	422	454	486	
1	1	1	0	0		7	39	71	103	135	167	199	231	263	295	327	359	391	423	455	487	
0	0	0	1	0		8	40	72	104	136	168	200	232	264	296	328	360	392	424	456	488	
1	0	0	1	0		9	41	73	105	137	169	201	233	265	297	329	361	393	425	457	489	
0	1	0	1	0		10	42	74	106	138	170	202	234	266	298	330	362	394	426	458	490	
1	1	0	1	0		11	43	75	107	139	171	203	235	267	299	331	363	395	427	459	491	
0	0	1	1	0		12	44	76	108	140	172	204	236	268	300	332	364	396	428	460	492	
1	0	1	1	0		13	45	77	109	141	173	205	237	269	301	333	365	397	429	461	493	
0	1	1	1	0		14	46	78	110	142	174	206	238	270	302	334	366	398	430	462	494	
1	1	1	1	0		15	47	79	111	143	175	207	239	271	303	335	367	399	431	463	495	
0	0	0	0	1		16	48	80	112	144	176	208	240	272	304	336	368	400	432	464	496	
1	0	0	0	1		17	49	81	113	145	177	209	241	273	305	337	369	401	433	465	497	
0	1	0	0	1		18	50	82	114	146	178	210	242	274	306	338	370	402	434	466	498	
1	1	0	0	1		19	51	83	115	147	179	211	243	275	307	339	371	403	435	467	499	
0	0	1	0	1		20	52	84	116	148	180	212	244	276	308	340	372	404	436	468	500	
1	0	1	0	1		21	53	85	117	149	181	213	245	277	309	341	373	405	437	469	501	
0	1	1	0	1		22	54	86	118	150	182	214	246	278	310	342	374	406	438	470	502	
1	1	1	0	1		23	55	87	119	151	183	215	247	279	311	343	375	407	439	471	503	
0	0	0	1	1		24	56	88	120	152	184	216	248	280	312	344	376	408	440	472	504	
1	0	0	1	1		25	57	89	121	153	185	217	249	281	313	345	377	409	441	473	505	
0	1	0	1	1		26	58	90	122	154	186	218	250	282	314	346	378	410	442	474	506	
1	1	0	1	1		27	59	91	123	155	187	219	251	283	315	347	379	411	443	475	507	
0	0	1	1	1		28	60	92	124	156	188	220	252	284	316	348	380	412	444	476	508	
1	0	1	1	1		29	61	93	125	157	189	221	253	285	317	349	381	413	445	477	509	
0	1	1	1	1		30	62	94	126	158	190	222	254	286	318	350	382	414	446	478	510	
1	1	1	1	1		31	63	95	127	159	191	223	255	287	319	351	383	415	447	479	511	

Dip Switch Position

DMX Address

General Troubleshooting

Symptom	Solution(s)
Auto shut off	Check thermal switch reset
Breaker/Fuse keeps blowing	Check total load placed on device
Device has no power	Check for power on Mains. Check device's fuse. (internal and/or external)
Fixture is not responding	Check DMX Dip switch settings for correct addressing Check DMX cables Check polarity switch settings
Fixture is on but there is no movement to the audio	Make sure you have the correct audio mode on the control switches. If audio provided via 1/4" jack, make sure a live audio signal exists Adjust sound sensitivity knob
Loss of signal	Use only DMX cables Install terminator Note: Keep DMX cables separated from power cables or black lights.
Remote does not work	Make sure connector is firmly connected to device
Stand alone mode	All Chauvet lighting fixtures featuring stand-alone functions do not require additional settings, simply power the fixture and it will automatically enter into this mode

If you still have a problem after trying the above solutions, please contact CHAUVET Technical Support at the location below.

Technical Support

Address: Service Dept.
3000 N 29th Ct, Hollywood, FL 33020 (U.S.A.)
Support (Email): tech@chauvetlighting.com
Telephone: (954) 929-1115 - (Press 4)
Fax: (954) 929-5560 - (Attention: Service)
Website: <http://www.chauvetlighting.com>

WARNING!

Note: *All haze machines are prone to clogging due to the thick consistency of haze fluid and the high temperature at which it vaporizes. However, a properly maintained haze machine should provide years of reliable use. Cleaning your haze machine regularly will help reduce costly replacement and repair charges.*

Maintenance

Do not allow the haze machine to become contaminated. After every 40 hours of continuous operation, it is recommended to run a cleaning solution composed of 80% distilled water and 20% distilled vinegar through the system to prevent the accumulation of particulate matter in the heating element.

The recommended cleaning regimen is as follows:

1. Empty all haze fluid from the machine. Add cleaning solution to tank. Plug unit in and begin warm up.
2. Run the unit in a well-ventilated area until the tank is almost empty. Do not allow the pump to run dry!
3. Cleaning is now complete. Refill with haze fluid. Run the machine briefly to clear any cleaning solution from the pump and heater.

Caution! *Do not operate the machine without fluid at any time!*

Storage

1. When storing run distilled water (not tap water) through the system as described in the cleaning regimen above. This will help avoid any particles condensing inside the pump or heater.
2. It is strongly recommended to test-run the machine on a monthly basis in order to achieve its best hazing condition.

Caution:

1. Never place the haze/hazer machine on any flammable material (i.e. carpet, fabric etc.) during operation. All haze/hazer machines should always be on a non-flammable surface, such as concrete or tile.
2. Depending on the amount of haze/haze generated, all haze machines may set off smoke detectors.

Returns Procedure

Returned merchandise must be sent prepaid and in the original packing, call tags will not be issued. Package must be clearly labeled with a Return Merchandise Authorization Number (RMA #). Products returned without an RMA # will be refused. Call CHAUVET and request RMA # prior to shipping the fixture. Be prepared to provide the model number, serial number and a brief description of the cause for the return. Be sure to properly pack fixture, any shipping damage resulting from inadequate packaging is the customer's responsibility. CHAUVET reserves the right to use its own discretion to repair or replace product(s). As a suggestion, proper UPS packing or double-boxing is always a safe method to use.

Note: If you are given an RMA #, please include the following information on a piece of paper inside the box:

- 1) Your name
- 2) Your address
- 3) Your phone number
- 4) The RMA #
- 5) A brief description of the symptoms

Claims

Damage incurred in shipping is the responsibility of the shipper; therefore the damage must be reported to the carrier upon receipt of merchandise. It is the customer's responsibility to notify and submit claims with the shipper in the event that a fixture is damaged due to shipping. Any other claim for items such as missing component/part, damage not related to shipping, and concealed damage, must be made within seven (7) days of receiving merchandise.

Technical Specifications

WEIGHT & DIMENSIONS

Length 11.1 in (284 mm)
Width 11.6 in (294 mm)
Height 14 in (360 mm)
Weight 17 lbs (7.6 kg)

POWER

Voltage-specific power input 115 VAC 60 Hz or 230 VAC 50 Hz
Power Consumption 510 W (4.2 A) max @ 120 V
Inrush Current 45.6 W (1.33 A) @ 120 V
Power Factor 0.99 @ 120 V

OUTPUT/FLUID CONSUMPTION

Output 12,000 cfm
Fluid consumption 21 ml/min

FUSE

115 VAC 5 A 250 V (fast blow)
230 VAC 3 A 250 V (fast blow)

COMPATIBLE FLUID

Haze Fluid Water-based

THERMAL

Maximum ambient temperature 104° F (40° C)

CONTROL & PROGRAMMING

Data input locking 3-pin XLR male socket
Data output locking 3-pin XLR female socket
Data pin configuration pin 1 shield, pin 2 (-), pin 3 (+)
Protocols DMX-512 USITT
DMX Channels 2

ORDERING INFORMATION

Hurricane™ Haze HURRICANEHAZE
Haze Fluid (gallon) FJU
Haze Fluid (quart) FJQ
Platinum Fluid HDF

WARRANTY INFORMATION

Warranty 2-year limited warranty